

Constant Current Regulator

FEATURES

- Constant Current Regulator
- Constant Current Option :
150/210/225/240/260/280/300/320/350 mA
- Low Dropout Voltage
- Low 0.1 uA Shutdown Supply Current
- SOT-89 and TO-252 lead-free Package
- ESD Human Body Mode Over 5KV
- 2.7V to 5V Supply Voltage Range
- Build in Thermal Protect 160 °C

APPLICATIONS

- Flash Light
- Lighting
- Portable Communication Devices
- Handheld Electronics
- DC/DC LED driver

TYPICAL APPLICATION CIRCUITS

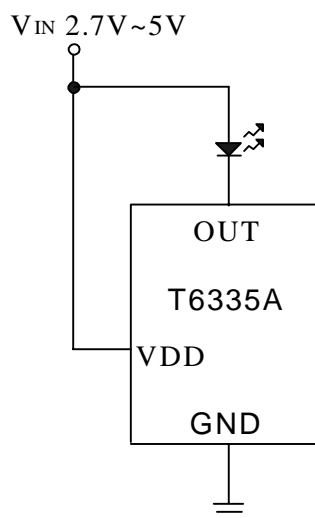

GENERAL DESCRIPTION

The T6335A low-dropout bias supply for white LED is a high-performance used in conventional white LED designs.

The T6335A has lower bias variation with supply voltage variation, significantly lower dropout voltage Low Shutdown Current in some applications, significantly improved efficiency from DC 2.7V to 5V. The T6335A is available in SOT-89 and TO-252 lead-free package.

PART NUMBER EXAMPLES

Part no.	Current	Package type
T6335A-350AXG	350mA	SOT-89
T6335A-350AWG	350mA	TO-252
⋮	⋮	⋮
⋮	⋮	⋮
T6335A-150AXG	150mA	SOT-89
T6335A-150AWG	150mA	TO-252

PIN ARRANGEMENT

(Top view)

SOT-89

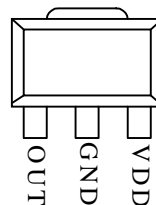

TO-252

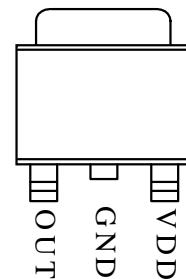

PIN DESCRIPTION

SYMBOL	Pin no.	DESCRIPTION
OUT	1	LED Cathode Connection.
VSS	2	Ground
VDD	3	Power supply

ABSOLUTE MAXIMUM RATINGS

Parameter	Symbol	Value	Unit
Voltage on any pin relative to GND	V _{IN}	-0.3 to 6	V
Operating Temperature Rang	T _A	-40 to +85	°C
Maximum Soldering Temperature (at leads, 10 sec)	T _{LEAD}	300	°C
Storage Temperature Rang	T _S	-65 to +150	°C
Continuous Power Dissipation (T _A = +70°C)		1	W

Electrical Characteristics

 (Typical values are at T_A =25°C)

Symbol	Description	Conditions	Min.	Typ.	Max	Unit	
V _{DD}	Operating voltage range	VDD is power supply input	2.7		5	V	
I _{LED}	Maximum LED sink current	VDD = 4.5V VLED =3.5V	T6335A-350	329	350	371	mA
			T6335A-320	300	320	339	mA
			T6335A-300	282	300	318	mA
			T6335A-280	263	280	296	mA
			T6335A-260	244	260	275	mA
			T6335A-240	225	240	254	mA
			T6335A-225	211	225	238	mA
			T6335A-210	197	210	222	mA
T6335A-150	141	150	159	mA			
T _{TP}	Thermat Protect			160		°C	
I _{LSD}	LED leakage current in shutdown	VDD = GND, VLED = 5V		0.2	1	uA	

Typical Operating Characteristics

Test Circuit

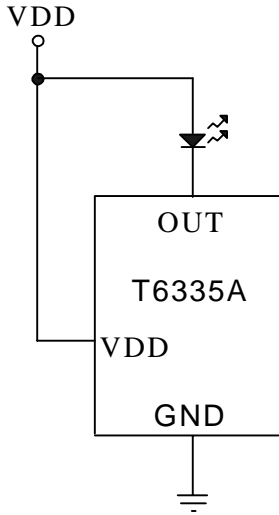

VDD VS. Iout Curve

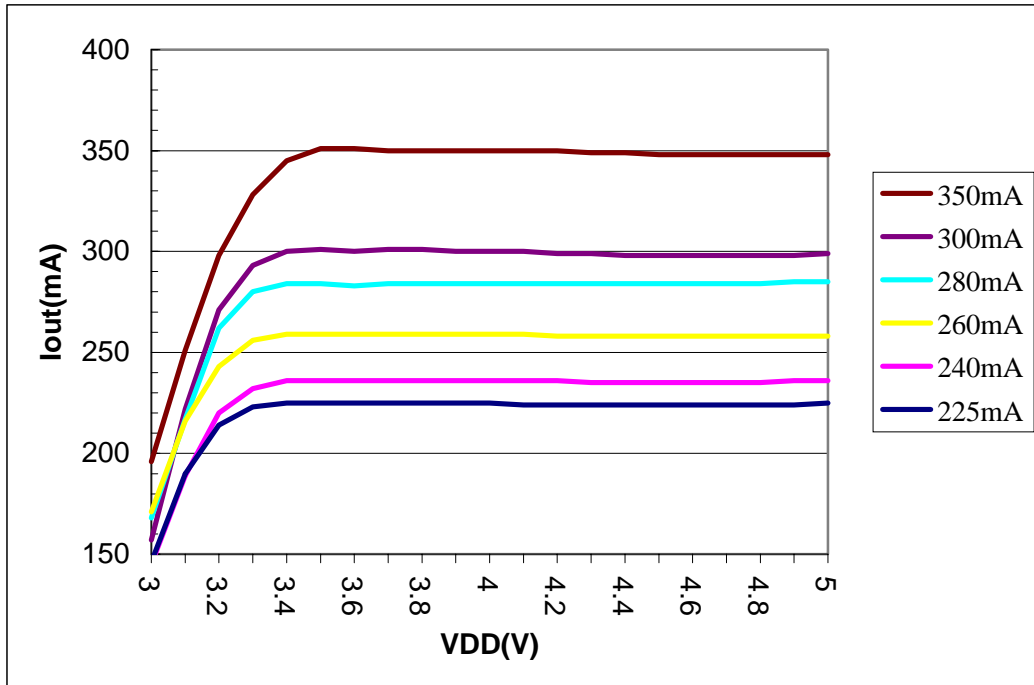

PACKAGE DIMENSIONS
SOT-89

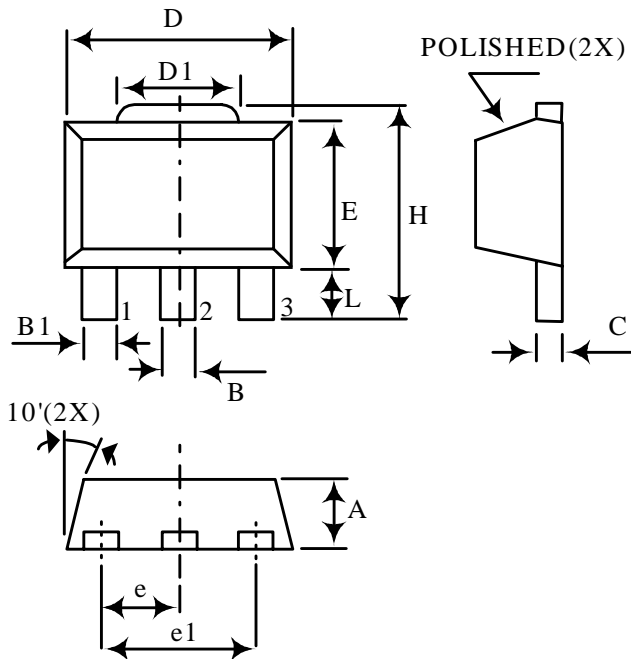

Symbol	Dimension in mm	
	Min.	Max.
A	1.40	1.60
B	0.44	0.56
B1	0.36	0.48
C	0.35	0.44
D	4.40	4.60
D1	1.35	1.83
E	2.29	2.60
H	3.94	4.25
e	1.50 BSC	
e1	3.00 BSC	
L	0.89	1.2

TO-252

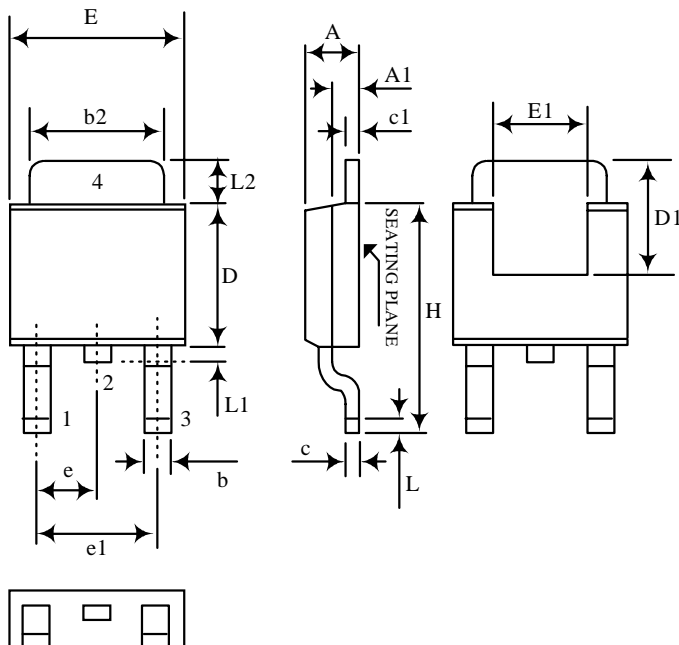

Symbol	Dimension in inch	
	Min.	Max.
A	0.086	0.094
A1	0.040	0.050
b	0.024 TYP.	
b2	0.205	0.215
c	0.018	0.023
c1	0.018	0.023
D	0.210	0.220
E	0.250	0.265
D1	0.180	-
E1	0.150	-
e	0.090 BSC.	
e1	0.180 BSC.	
H	0.370	0.410
L	0.020	-
L1	0.025	0.040
L2	0.060	0.080